

Article number: 2314452771

Description: E+G Cast iron wheel 452771
RE.G2-100-RSL - loose wheel with ball bearings

Measures

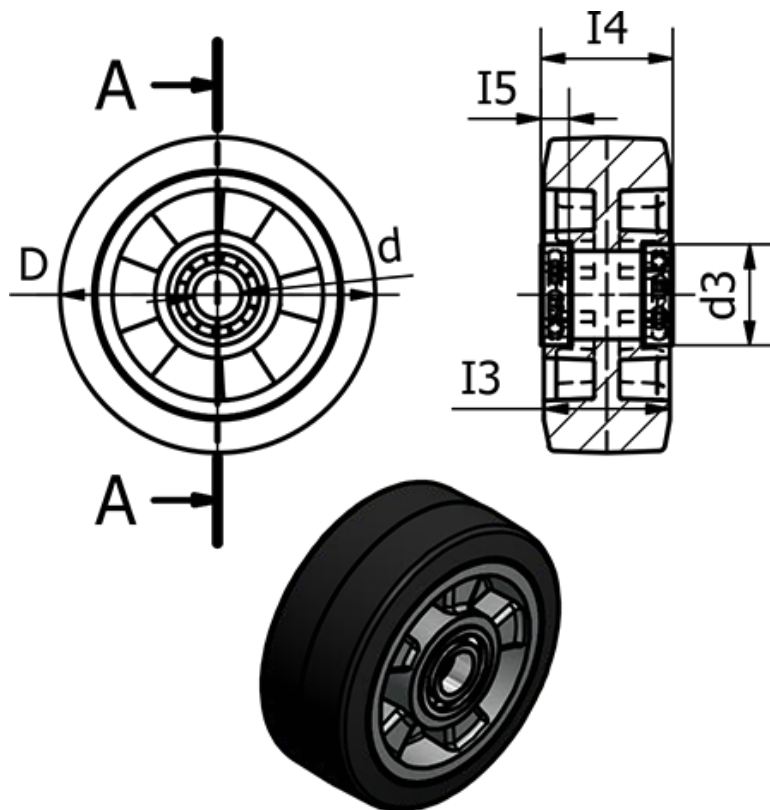

	= -	I5	= 9
	= -	Rolling resistance (N)	= 1800
Code	= 542771	Static load	= 2500
d	= 100	Type	= RE.G2-100-RSL
d3	= 32	Wight (g)	= 440
Dynamic carrying capacity (N)	= 1800		
I3	= 40		
I4	= 40		